

brickends

new, discontinued and collectible LEGO® sets

Company Number: 7190449

Registered Office: 80 Abington Street, Northampton, NN1 2BB,



7

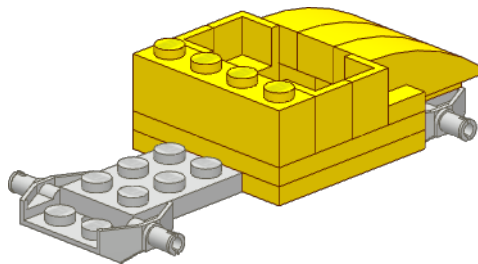
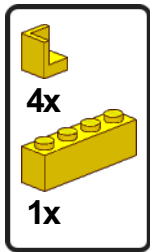

8

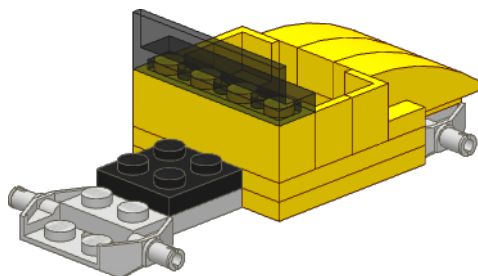
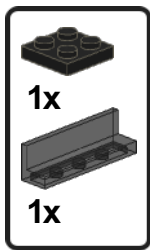

9

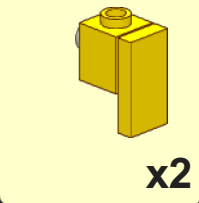
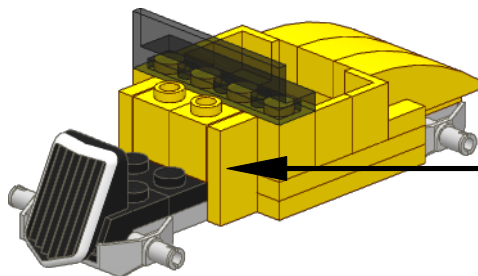

10

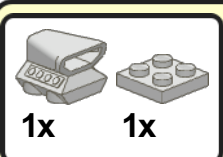
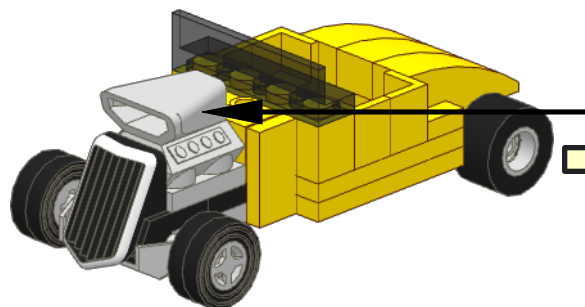

brickends

new, discontinued and collectible LEGO® sets

Company Number: 7190449

Registered Office: 80 Abington Street, Northampton, NN1 2BB,

